

Accesorios para unidad de guía

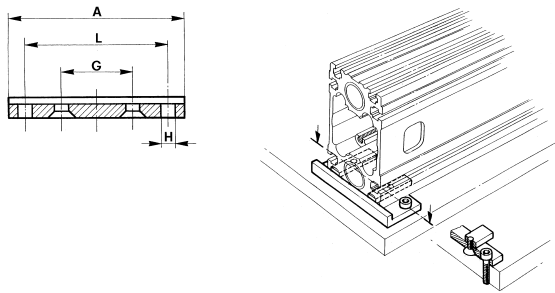

Pies de fijación en aluminio

TALLA	A	B	C	D	E	F	G	H	L	Código
16	52	30	10	26	4	9	20	Ø 4,5	43	JF-13016
25	70	30	10	26	4	9	32	Ø 5,5	57	JF-13025
32	85	35	10	30	5	10	38	Ø 6,5	72	JF-13032
40	92	35	10	30	5	10	42	Ø 6,5	79	JF-13040
50	111	40	15	35	5	12,5	48	Ø 8,5	102	JF-13050
63	131	45	15	40	5	15	56	Ø 10,5	112	JF-13063
80	161	45	15	40	5	15	65	Ø 10,5	135	JF-13080
100	171	45	15	40	5	15	72	Ø 10,5	151	JF-13100



La fijación consta de 2 piezas completas de accesorios para su montaje.

Plaquetas de fijación de acero

TALLA	A	B	C	D	E	F	Código
16	3	7	7,5	15	30	M4	JF-42016
25	4	8	10	15	35	M5	JF-42025
32 - 40	4	10	10	20	40	M6	JF-42040
50	6	13	10	30	50	M8	JF-42050
63	6	16	12,5	35	60	M10	JF-42063
80 - 100	8	16	15	40	70	M10	JF-42100

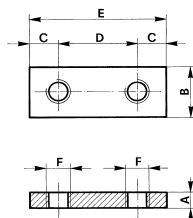

La fijación consta de 2 piezas completas de accesorios para su montaje.

Soporte de varillas para unidades de guía serie J10/J11/J12

TALLA	Código
16	JF-601016
25	JF-601025
32	JF-601032
40	JF-601040
50	JF-601050
63	JF-601063
80	JF-601080
100	JF-601100

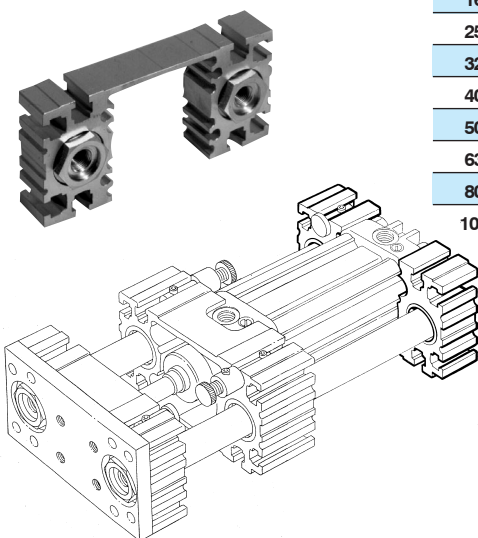

TALLA	A	B	C	D	E	F	G	H	Código
16	50	30	10	26	3	9	31	Ø 4,5	JF-14016
25	55	30	10	26	3	9	34	Ø 5,5	JF-14025
32	60	35	10	30	4	10	38	Ø 6,5	JF-14032
40	65	35	10	30	4	10	40	Ø 6,5	JF-14040
50	70	40	15	35	4	12,5	45	Ø 8,5	JF-14050
63	85	45	15	40	4	15	56	Ø 10,5	JF-14063
80 - 100	90	45	15	40	4	15	58	Ø 10,5	JF-14100

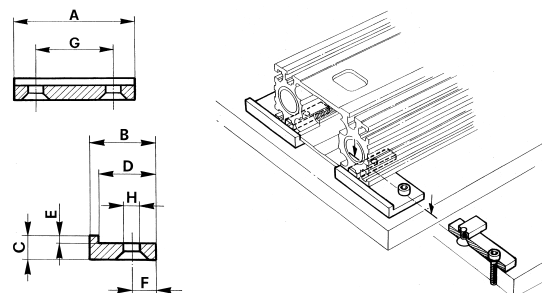

La fijación consta de 4 piezas completas de accesorios para su montaje.

TALLA	A	B	C	D	Código
16	3	7	16	M4	JF-43016
25	4	8	16	M5	JF-43025
32 - 40	4	10	18	M6	JF-43040
50	6	13	18	M8	JF-43050
63	6	16	22	M10	JF-43063
80 - 100	8	16	25	M10	JF-43100

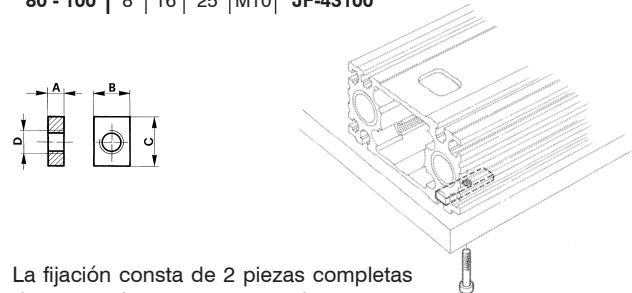

La fijación consta de 2 piezas completas de accesorios para su montaje.

Casquillos limpiabarras

TALLA	Ø A	Código
16	12	JF-19016
25	16	JF-19025
32	20	JF-19032
40	22	JF-19040
50	25	JF-19050
63	28	JF-19063
80 - 100	32	JF-19100

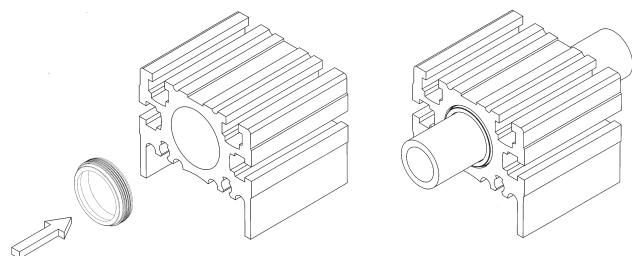
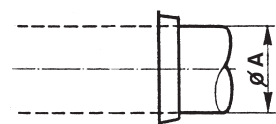

El envase de venta incluye 2 unidades.